



YOUR PARTNER IN SENSOR TECHNOLOGY

ELEKTRONIK
Ges.m.b.H.

USER'S GUIDE

EE650 - Air Velocity Transmitter for HVAC Applications

GENERAL

The EE650 transmitter is designed for accurate measurement of air velocity in HVAC. It operates on the hot-film anemometer principle and features the innovative, very robust E+E VTQ sensing element manufactured in thin-film technology combined with state-of-the-art transfer molding.

The construction of the sensing head leads to a very low angular dependence which facilitate the installation. The mounting flange allows for easy adjustment of the immersion depth.

The measuring range and the response time of EE650 can be selected with jumpers on the electronics board, see below "Settings".

EE650 is dedicated for heating, ventilation and air conditioning applications. For special applications do not hesitate to contact the manufacturer or their local distributor.

CAUTION

- Accurate measurement results are conditioned by the correct positioning of the sensing probe in the air stream. Best accuracy is achieved in laminar flow.
- Observe the minimum inlet and outlet path length, see page 4.
- Avoid mechanical stress onto the probe and mainly onto the sensing head.
- Observe the humidity working range 5 ... 95% RH, non-condensing.
- Avoid installation in corrosive environment, as this may lead to sensor destruction.

SETTINGS

For performing EE650 settings via EE-PCS Product Configuration Software (download from www.epluse.com/configurator) the working range jumper must be on HI.

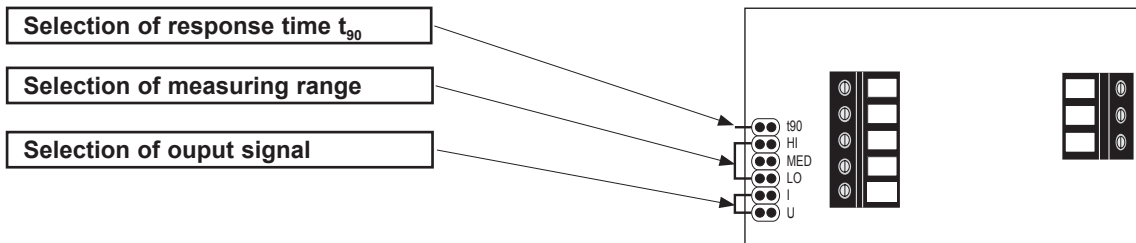

Selection of output signal

Jumper I
 CURRENT
 (factory setting)

Jumper U
 VOLTAGE

Selection of response time t₉₀

Jumper t90
 SLOW 4 sec.
 (factory setting)

no jumper
 FAST 1 sec.

Selection of measuring range

Jumper HI
 0...20 m/s (0...4000 ft/min)
 (factory setting)

Jumper MED
 0...15 m/s (0...3000 ft/min)

Jumper LO
 0...10 m/s (0...2000 ft/min)

CONNECTING DIAGRAM

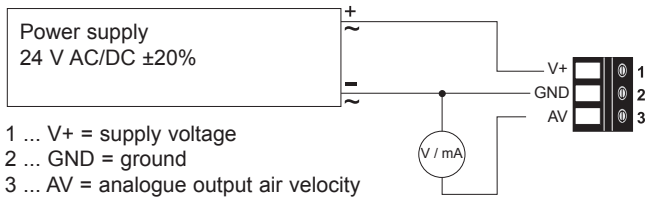

Remote sensor probe

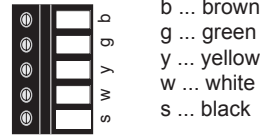

TECHNICAL DATA

Measuring range

Working range ¹⁾	0...10 m/s (0...2000 ft/min)	
	0...15 m/s (0...3000 ft/min)	
	0...20 m/s (0...4000 ft/min) (factory setting)	
Output ¹⁾	0 - 10 V	-1 mA < I _L < 1 mA
0...10 m/s / 0...15 m/s / 0...20 m/s	4 - 20 mA (factory setting)	R _L < 500 Ω (linear, 3-wires)
Accuracy at 20 °C (68 °F), 45 % RH, 1013 hPa	0.2...10 m/s (40...2000 ft/min)	± (0.2 m/s (40 ft/min) + 3 % of m. v.)
	0.2...15 m/s (40...3000 ft/min)	± (0.2 m/s (40 ft/min) + 3 % of m. v.)
	0.2...20 m/s (40...4000 ft/min)	± (0.2 m/s (40 ft/min) + 3 % of m. v.)
Response time τ ₉₀ ^{1) 2)}	typ. 4 sec. (factory setting) or	typ. 1 sec. at constant temperature

General

Power supply	24V AC/DC ± 20 %		
Current consumption	for AC supply	max. 170 mA	
	for DC supply	max. 70 mA	
Electrical connection	screw terminals max. 1.5 mm ² (AWG 16)		
Cable gland	M16x1.5		
Electromagnetic compatibility	EN61326-1	EN61326-2-3	ICES-003 ClassB FCC Part 15
Housing material	Polycarbonate, UL94V-0 approved		
Protection class	Enclosure IP65 / NEMA 4, remote probe IP20		
Temperature range	working temperature probe	-25 ... +50 °C (-13...122 °F)	
	working temperature electronic	-10 ... +50 °C (14...122 °F)	
	storage temperature	-30 ... +60 °C (-22...140 °F)	
Working range humidity	5...95 % RH (non-condensing)		

1) Selectable by jumper

2) Response time τ₉₀ is measured from the beginning of a step change of air velocity to the moment of reaching 90% of the step.

DIMENSIONS MM (INCH)

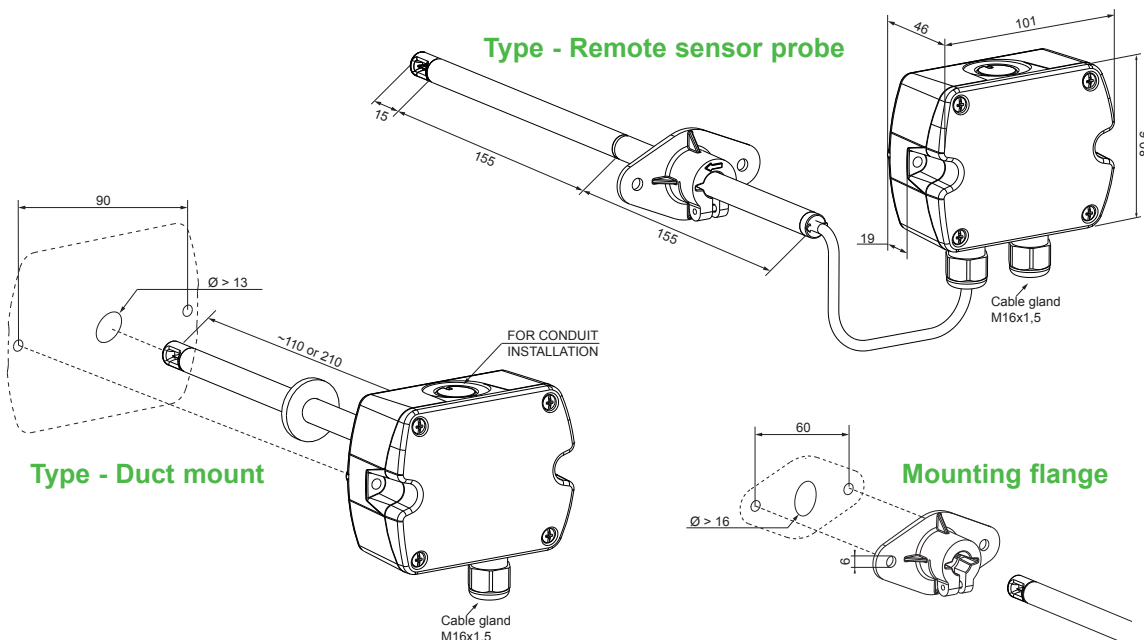

CONFIGURATION AND ADJUSTMENT

The EE650 as ordered is ready for use immediately and requires no configuration by the user. If required, the optional E+E Product Configuration Adapter (EE-PCA) and the E+E Product Configuration Software (EE-PCS) can be used for changing the factory setup as well as for adjusting of the air velocity measurement. Additionally, it allows for setting the display backlighting and orientation.

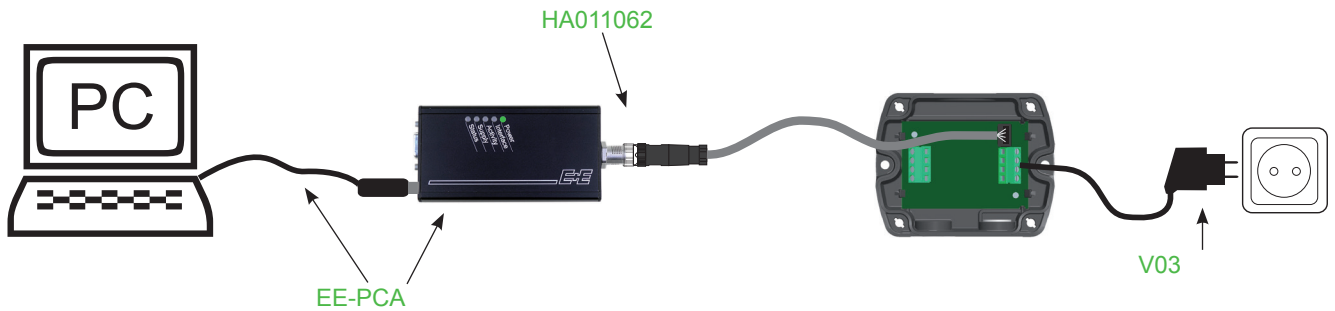

For product data sheets EE-PCS and EE-PCA please see www.epluse.com.

The E+E Product Configuration Software (EE-PCS) is free and can be downloaded from www.epluse.com/configurator.

MOUNTING

DRILLING IN THE WALL OF THE DUCT FOR INSTALLING THE MOUNTING FLANGE

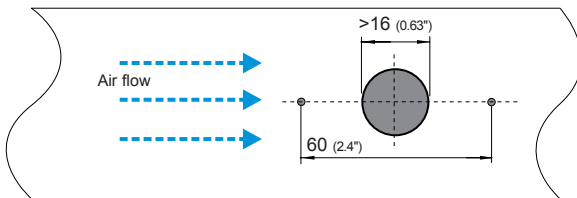

The arrow engraved on the sensing head of EE650 indicates the direction of the air stream during factory adjustment. When installing the EE650 probe, make sure that the arrow matches exactly the flow direction.



The mounting flange allows for precise setting of the EE650 immersion depth in a duct. The entire sensing head must be in the air flow to be measured.

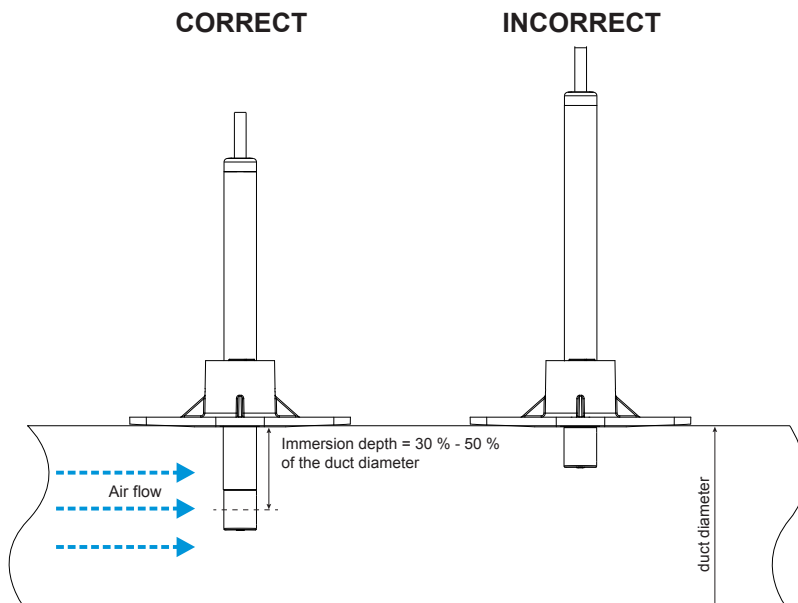

POSITIONING OF AIR VELOCITY SENSOR IN A VENTILATION DUCT

The reliable and accurate measurement of air velocity depends on the correct positioning of the sensor in the ventilation duct. Accurate measurements are only possible if the air velocity probe is positioned at a location with a laminar (to-turbulent) flow.

The required length of the calming section after a fault is a function of the tube diameter D. For a rectangular channel a x b applies:

$$D_{gl} = \frac{2 \cdot a \cdot b}{a + b}$$



Mounting the sensing probe in the middle of the channel.

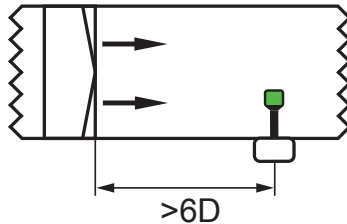
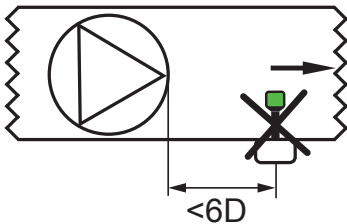

The optimal position is after the filter. Please note sufficient distance.

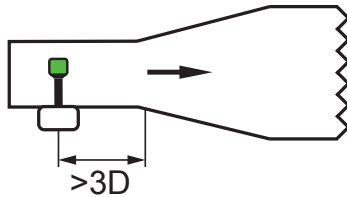
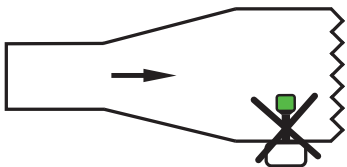

Positioning the probe ahead of diffuser, at a place with high flow rate.

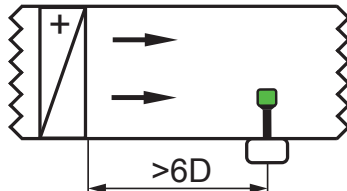
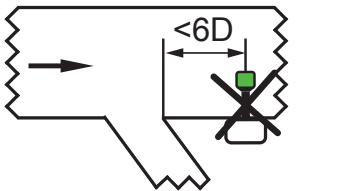

Positioning the probe at a location with a laminar (to-turbulent) flow.

Turbulent flows are caused by pipe bends, branches, behind flaps, flans, air heaters, air coolers or cross-sectional changes.

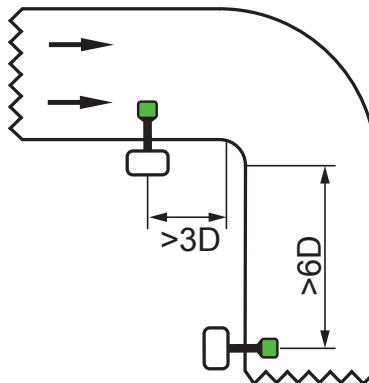
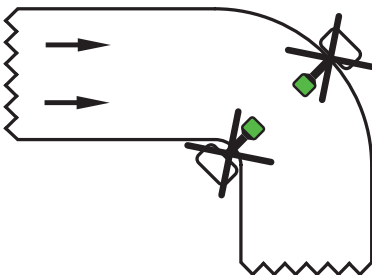

MAINTENANCE OF THE E+E AIR VELOCITY TRANSMITTERS

Due to the absence of moving parts, the E+E air velocity transmitters are not subject to wear. The construction (shape, dimensions and materials) of the hot film air velocity sensor is per se highly insensitive to dust and dirt. No maintenance is required under normal environmental conditions. For operation in polluted environment it is advisable to periodically clean the sensing head by washing it in isopropyl alcohol, preferably in an ultrasound cleaner. Alternatively shake it gently few minutes in a pot with isopropyl alcohol and let it dry free. Do not touch or rub the sensor and do not use any mechanical tools for cleaning.

SCOPE OF SUPPLY

- EE650 Transmitter according to ordering guide
- Cable gland
- Mounting flange
- Mounting materials
- Protection cap
- Instruction manual
- Two self-adhesive labels for configuration changes (see user guide at www.epluse.com/relabeling)
- Test report according to DIN EN10204 - 2.2

ACCESSORIES

- Product configuration adapter
- Product configuration software
- Power supply adapter

see data sheet [EE-PCA](#)
[EE-PCS](#) (free download: www.epluse.com/EE650)
[V03](#) (see data sheet Accessories)

USA

FCC notice:

This equipment has been tested and found to comply with the limits for a Class B digital device, pursuant to part 15 of the FCC Rules. These limits are designed to provide reasonable protection against harmful interference in a residential installation. This equipment generates, uses and can radiate radio frequency energy and, if not installed and used in accordance with the installation manual, may cause harmful interference to radio communications. However, there is no guarantee that interference will not occur in a particular installation. If this equipment does cause harmful interference to radio or television reception, which can be determined by turning the equipment off and on, the user is encouraged to try to correct the interference by one or more of the following measures:

- Reorient or relocate the receiving antenna.
- Increase the separation between the equipment and receiver.
- Connect the equipment into an outlet on a circuit different from that to which the receiver is connected.
- Consult the dealer or an experienced radio/TV technician for help.

CANADIAN

ICES-003 Issue 5:

CAN ICES-3 B / NMB-3 B

INFORMATION

+43 7235 605 0 / info@epluse.com

E+E Elektronik Ges.m.b.H.
Langwiesen 7 • A-4209 Engerwitzdorf
Tel: +43 7235 605-0 • Fax: +43 7235 605-8
info@epluse.com • www.epluse.com
LG Linz Fn 165761 t • UID-Nr. ATU44043101
Place of Jurisdiction: A-4020 Linz • DVR0962759

